

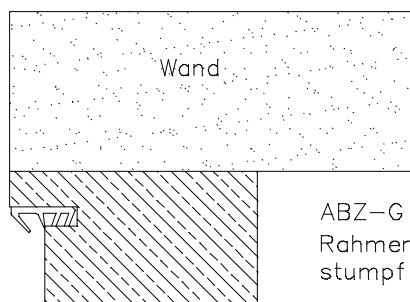

## Landhaus Blendrahmen ABZ

Kiefer astig / Fichte astig / Fichte astig gebürstet

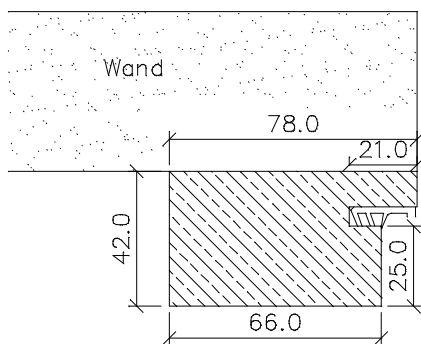

ABZ-G  
Rahmenverbindung  
stumpf

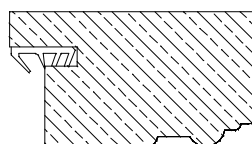
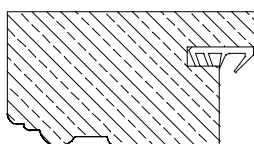

ABZ-LH  
Rahmenverbindung  
auf Gehring

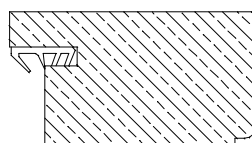
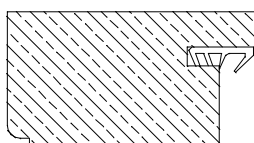

ABZ-INL  
Rahmenverbindung  
auf Gehring

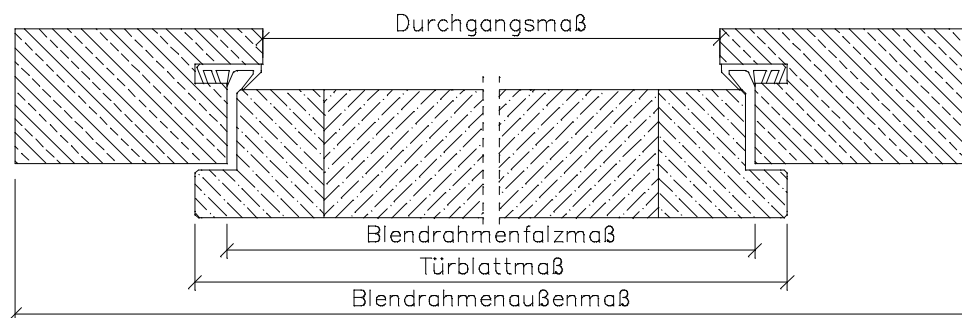

	Türbreite	Blendrahmenfalzmaß	Blendrahmendurchgangsmaß	Blendrahmenaußenmaß
	610	590	566	722
	735	715	691	847
	860	840	816	972
	985	965	941	1097
	610 + 610 (1210)	1190	1166	1322
	735 + 610 (1335)	1315	1291	1447
	735 + 735 (1460)	1440	1416	1572
	860 + 735 (1585)	1565	1541	1697
	860 + 860 (1710)	1690	1666	1822
	985 + 860 (1835)	1815	1791	1947
	985 + 985 (1960)	1940	1916	2072
<b>Höhe</b>	1985	1982	1970	2048